



### NEW PERFORM-RA

Lavov downlight from the family NEW PERFORM-RA with a power of 15W and a beam angle of 60°. Finished in White trim and black reflector. Dimensions  $\varnothing 90 \times H62$ mm. With a total lumen output of 1500lm and a luminous efficacy of 100lm/W. Made in Die Cast Aluminum. Driver DALI. CCT 4000K. UGR19.

#### Dimensions

Product dimensions (mm)  $\varnothing 90 \times H62$ mm

#### Scheme

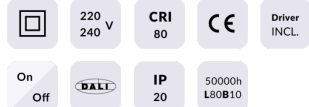

Item code	86.D122.1433.B1
Product type	Indoor
Category	Downlights
Family	NEW PERFORM
Subfamily	NEW PERFORM-RA
Pictograms	

Product	
Real power (W)	15
Real luminous flux (Lm)	1500
Luminous efficiency (Lm/W)	100
Beam angle (°)	60
Life time (h)	50000 h L80B10
IP	20
Electrical class insulation	Clas II
Colour	White trim and black reflector
U. G. R	19
Control gear included	Yes
Control gear	DALI
Flicker Free	Yes
Light source	LED
Type of LED	COB
Colour temperature (K)	4000
Colour consistency (SDCM)	SDCM3
CRI	80