

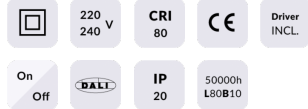

NEW PERFORM-S

Lavov downlight from the family NEW PERFORM-S with a power of 25W and a beam angle of 24°. Finished in White trim and black reflector. Dimensions 115*115*H73mm. With a total lumen output of 2500lm and a luminous efficacy of 100lm/W. Made in Die Cast Aluminum. Driver ON/OFF. CCT 4000K. UGR19.

Item code	86.D125.2411.B1
Product type	Indoor
Category	Downlights
Family	NEW PERFORM
Subfamily	NEW PERFORM-S
Pictograms	

Dimensions

Product dimensions (mm) **115*115*H73mm**

Scheme

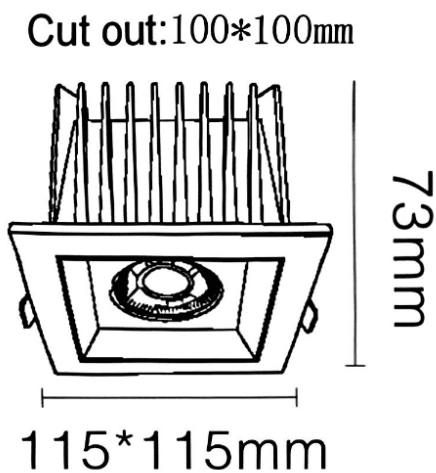

Product	
Real power (W)	25
Real luminous flux (Lm)	2500
Luminous efficiency (Lm/W)	100
Beam angle (°)	24
Life time (h)	50000 h L80B10
IP	20
Electrical class insulation	Clas II
Colour	White trim and black reflector
U. G. R	19
Control gear included	Yes
Control gear	ON/OFF
Flicker Free	Yes
Light source	LED
Type of LED	COB
Colour temperature (K)	4000
Colour consistency (SDCM)	SDCM3
CRI	80