



PTT R

Lavov downlight from the family PTT R with a power of 18W and a beam angle of 24°. Finished in White colour. Trim version. With a total lumen output of 1800lm and a luminous efficacy of 100lm/W. Made in Die Cast Aluminum. Driver DALI. CCT 3000K.

Item code	86.D146.3323.01
Product type	Indoor
Category	Downlights
Family	PTT
Subfamily	PTT R
Pictograms	

Dimensions

Product dimensions (mm) $\varnothing 84 \times H105 \text{mm}$

Scheme

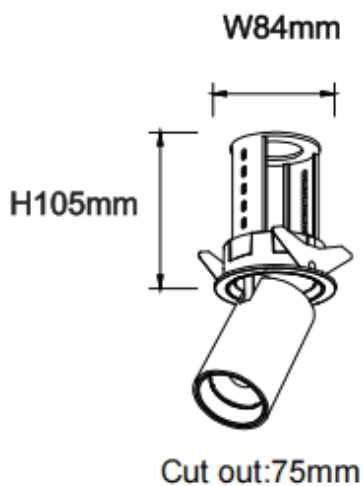

Product	
Real power (W)	18
Real luminous flux (Lm)	1800
Luminous efficiency (Lm/W)	100
Beam angle (º)	24
Life time (h)	50000 h L80B10
Colour	White
Control gear included	Yes
Control gear	DALI
Flicker Free	Yes
Light source	LED
Type of LED	COB
Colour temperature (K)	3000
Colour consistency (SDCM)	SDCM<3
CRI	90