



### PTT R

Lavov downlight from the family PTT R with a power of 18W and a beam angle of 36°. Finished in Black colour. Trim version. With a total lumen output of 1800lm and a luminous efficacy of 100lm/W. Made in Die Cast Aluminum. Driver DALI. CCT 3000K.

Item code	86.D146.3333.02
Product type	Indoor
Category	Downlights
Family	PTT
Subfamily	PTT R
Pictograms	

### Dimensions

Product dimensions (mm)  $\varnothing 84 \times H105 \text{mm}$

### Scheme

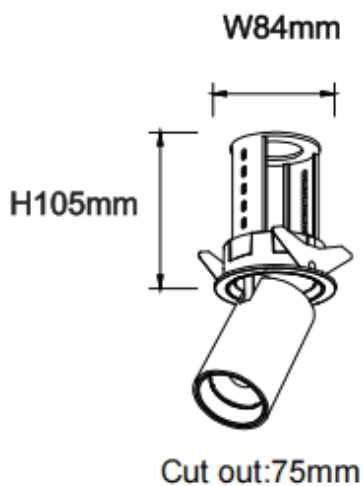

Product	
Real power (W)	18
Real luminous flux (Lm)	1800
Luminous efficiency (Lm/W)	100
Beam angle (°)	36
Life time (h)	50000 h L80B10
Colour	Black
Control gear included	Yes
Control gear	DALI
Flicker Free	Yes
Light source	LED
Type of LED	COB
Colour temperature (K)	3000
Colour consistency (SDCM)	SDCM3
CRI	90