



PTT R2

Lavov downlight from the family PTT R2 with a power of 2x30W and a beam angle of 55°. Finished in White colour. Trim version. With a total lumen output of 6000lm and a luminous efficacy of 100lm/W. Made in Die Cast Aluminum. Driver DALI. CCT 3000K.

Item code	86.D147.4343.01
Product type	Indoor
Category	Downlights
Family	PTT
Subfamily	PTT R2
Pictograms	

Dimensions

Product dimensions (mm) Ø222x108xH140mm

Scheme

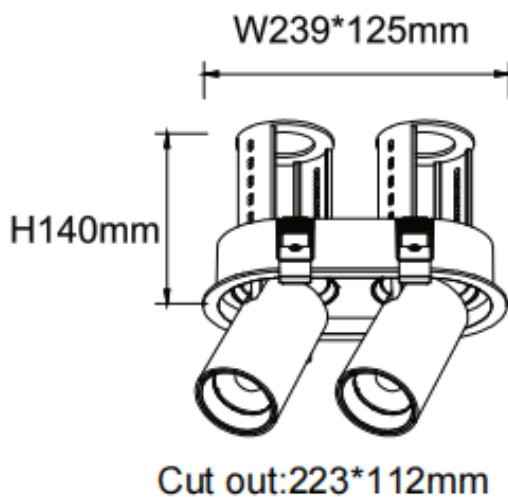

Product

Real power (W)	2x30
Real luminous flux (Lm)	6000
Luminous efficiency (Lm/W)	100
Beam angle (°)	55
Life time (h)	50000 h L80B10
Colour	White
Control gear included	Yes
Control gear	DALI
Flicker Free	Yes
Light source	LED
Type of LED	COB
Colour temperature (K)	3000
Colour consistency (SDCM)	SDCM3
CRI	90