

**PTT RT2**

Lavov downlight from the family PTT RT2 with a power of 2x7W and a beam angle of 55°. Finished in White colour. Trimless version. With a total lumen output of 1400lm and a luminous efficacy of 100lm/W. Made in Die Cast Aluminum. Driver ON/OFF. CCT 3000K.

Item code	86.D149.1341.01
Product type	Indoor
Category	Downlights
Family	PTT
Subfamily	PTT RT2
Pictograms	

Dimensions

Product dimensions (mm) **ø113x63xH90mm**

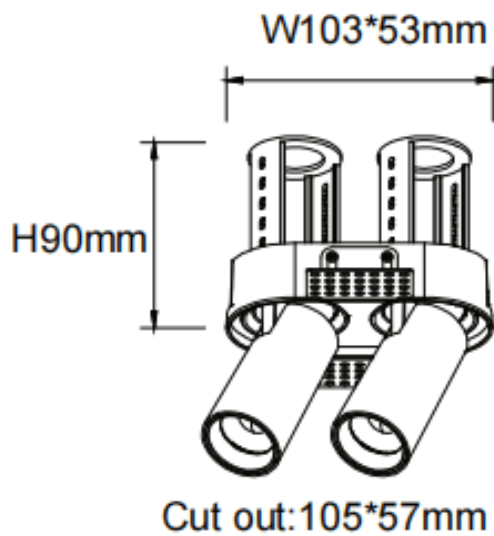
Scheme

Product	
Real power (W)	2x7
Real luminous flux (Lm)	1400
Luminous efficiency (Lm/W)	100
Beam angle (°)	55
Life time (h)	50000 h L80B10
Colour	White
Control gear included	Yes
Control gear	ON/OFF
Flicker Free	Yes
Light source	LED
Type of LED	COB
Colour temperature (K)	3000
Colour consistency (SDCM)	SDCM3
CRI	90