

**PTT RT2**

Lavov downlight from the family PTT RT2 with a power of 2x10W and a beam angle of 24°. Finished in White colour. Trimless version. With a total lumen output of 2000lm and a luminous efficacy of 100lm/W. Made in Die Cast Aluminum. Driver DALI. CCT 4000K.

<b>Item code</b>	<b>86.D149.2423.01</b>
<b>Product type</b>	<b>Indoor</b>
<b>Category</b>	<b>Downlights</b>
<b>Family</b>	<b>PTT</b>
<b>Subfamily</b>	<b>PTT RT2</b>
<b>Pictograms</b>	

**Dimensions**

**Product dimensions (mm)**      **ø140x79xH91mm**

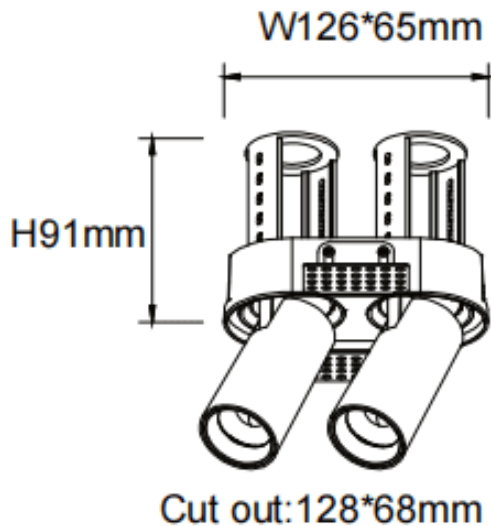
**Scheme**

<b>Product</b>	
<b>Real power (W)</b>	<b>2x10</b>
<b>Real luminous flux (Lm)</b>	<b>2000</b>
<b>Luminous efficiency (Lm/W)</b>	<b>100</b>
<b>Beam angle (&amp;ordm;)</b>	<b>24</b>
<b>Life time (h)</b>	<b>50000 h L80B10</b>
<b>Colour</b>	<b>White</b>
<b>Control gear included</b>	<b>Yes</b>
<b>Control gear</b>	<b>DALI</b>
<b>Flicker Free</b>	<b>Yes</b>
<b>Light source</b>	<b>LED</b>
<b>Type of LED</b>	<b>COB</b>
<b>Colour temperature (K)</b>	<b>4000</b>
<b>Colour consistency (SDCM)</b>	<b>SDCM&lt;3</b>
<b>CRI</b>	<b>90</b>