



PTT ST

Lavov downlight from the family PTT ST with a power of 10W and a beam angle of 15°. Finished in Black colour. Trimless version. With a total lumen output of 1000lm and a luminous efficacy of 100lm/W. Made in Die Cast Aluminum. Driver DALI. CCT 4000K.

Item code	86.D152.2413.02
Product type	Indoor
Category	Downlights
Family	PTT
Subfamily	PTT ST
Pictograms	

Dimensions

Product dimensions (mm) $\varnothing 62 \times H86 \text{mm}$

Scheme

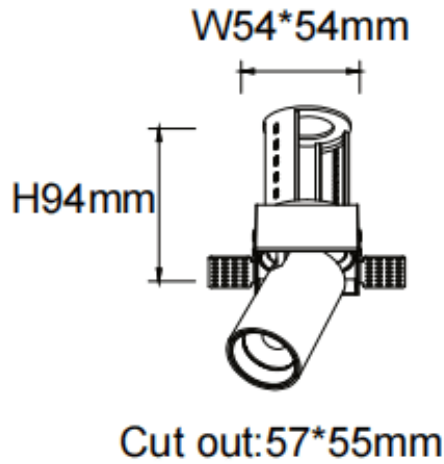

Product	
Real power (W)	10
Real luminous flux (Lm)	1000
Luminous efficiency (Lm/W)	100
Beam angle (°)	15
Life time (h)	50000 h L80B10
Colour	Black
Control gear included	Yes
Control gear	DALI
Flicker Free	Yes
Light source	LED
Type of LED	COB
Colour temperature (K)	4000
Colour consistency (SDCM)	SDCM3
CRI	90