



PTT ST2

Lavov downlight from the family PTT ST2 with a power of 2x7W and a beam angle of 24°. Finished in Black colour. Trimless version. With a total lumen output of 1400lm and a luminous efficacy of 100lm/W. Made in Die Cast Aluminum. Driver DALI. CCT 4000K.

Item code	86.D153.1423.02
Product type	Indoor
Category	Downlights
Family	PTT
Subfamily	PTT ST2
Pictograms	

Dimensions

Product dimensions (mm) **ø113x63xH90mm**

Scheme

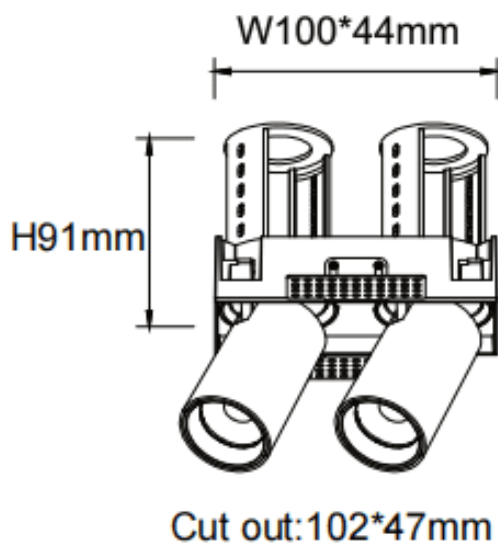

Product	
Real power (W)	2x7
Real luminous flux (Lm)	1400
Luminous efficiency (Lm/W)	100
Beam angle (&ordm;)	24
Life time (h)	50000 h L80B10
Colour	Black
Control gear included	Yes
Control gear	DALI
Flicker Free	Yes
Light source	LED
Type of LED	COB
Colour temperature (K)	4000
Colour consistency (SDCM)	SDCM<3
CRI	90