



PTT ST2

Lavov downlight from the family PTT ST2 with a power of 2x10W and a beam angle of 24°. Finished in Black colour. Trimless version. With a total lumen output of 2000lm and a luminous efficacy of 100lm/W. Made in Die Cast Aluminum. Driver ON/OFF. CCT 4000K.

Item code	86.D153.2421.02
Product type	Indoor
Category	Downlights
Family	PTT
Subfamily	PTT ST2
Pictograms	

Dimensions

Product dimensions (mm) $\varnothing 140 \times 79 \times H91 \text{mm}$

Scheme

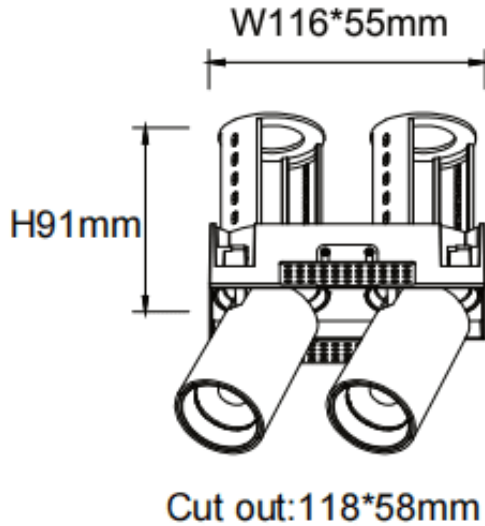

Product	
Real power (W)	2x10
Real luminous flux (Lm)	2000
Luminous efficiency (Lm/W)	100
Beam angle (º)	24
Life time (h)	50000 h L80B10
Colour	Black
Control gear included	Yes
Control gear	ON/OFF
Flicker Free	Yes
Light source	LED
Type of LED	COB
Colour temperature (K)	4000
Colour consistency (SDCM)	SDCM<3
CRI	90