



PTT ST2

Lavov downlight from the family PTT ST2 with a power of 2x18W and a beam angle of 24°. Finished in White colour. Trimless version. With a total lumen output of 3600lm and a luminous efficacy of 100lm/W. Made in Die Cast Aluminum. Driver ON/OFF. CCT 3000K.

Item code	86.D153.3321.01
Product type	Indoor
Category	Downlights
Family	PTT
Subfamily	PTT ST2
Pictograms	

Dimensions

Product dimensions (mm) **∅194x105xH105mm**

Scheme

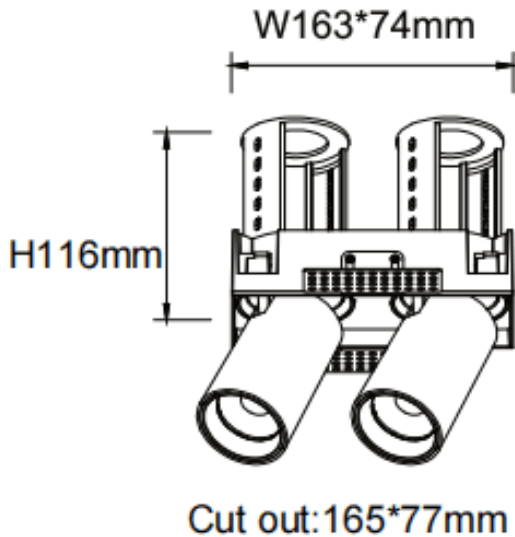

Product	
Real power (W)	2x18
Real luminous flux (Lm)	3600
Luminous efficiency (Lm/W)	100
Beam angle (&ordm;)	24
Life time (h)	50000 h L80B10
Colour	White
Control gear included	Yes
Control gear	ON/OFF
Flicker Free	Yes
Light source	LED
Type of LED	COB
Colour temperature (K)	3000
Colour consistency (SDCM)	SDCM<3
CRI	90