



ZENITH IP65R X2

Lavov downlight from the family ZENITH IP65R X2 with a power of 2X7W and a 24 degrees beam angle. CCT 4000K. White color. With a total lumen output of 2X560lm and a luminous efficacy of 80lm/W. Made in Die Cast Aluminum. IP65degree of protection. Class II isolation. DALI driver. UGR19. CRI90.

Item code	86.D284.0423.01
Product type	Indoor
Category	Downlights
Family	ZENITH
Subfamily	ZENITH IP65R X2
Pictograms	

Dimensions

Product dimensions (mm) **Φ79X140xH75mm**

Scheme

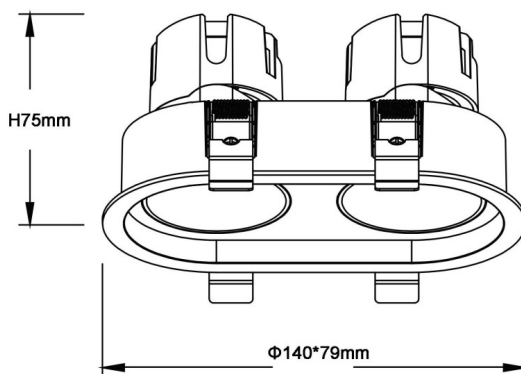

Product	
Real power (W)	2X7
Real luminous flux (Lm)	2X560
Luminous efficiency (Lm/W)	80
Beam angle (°)	24
Life time (h)	50000 h L80B10
IP	65
Electrical class insulation	Clas II
Colour	White
U. G. R	19
Control gear included	Yes
Control gear	DALI
Flicker Free	Yes
Light source	LED
Type of LED	COB
Colour temperature (K)	4000
Colour consistency (SDCM)	SDCM3
CRI	90