



ZENITH IP65R X2 Smart

Lavov downlight from the family ZENITH IP65R X2 Smart with a power of 2X7W and a 24 degrees beam angle. CCT 4000K. White color. With a total lumen output of 2X560lm and a luminous efficacy of 80lm/W. Made in Die Cast Aluminum. IP65degree of protection. Class II isolation. DALI wireless Casamby driver. UGR19. CRI90.

| | |
|--------------|-----------------------|
| Item code | 86.D284.0429.01 |
| Product type | Indoor |
| Category | Downlights |
| Family | ZENITH |
| Subfamily | ZENITH IP65R X2 Smart |
| Pictograms | |

Dimensions

Product dimensions (mm) $\Phi 79 \times 140 \times H75 \text{mm}$

Scheme

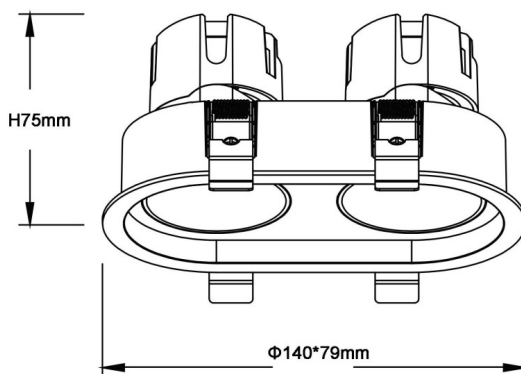

| | |
|-----------------------------|-----------------------|
| Product | |
| Real power (W) | 2X7 |
| Real luminous flux (Lm) | 2X560 |
| Luminous efficiency (Lm/W) | 80 |
| Beam angle (º) | 24 |
| Life time (h) | 50000 h L80B10 |
| IP | 65 |
| Electrical class insulation | Clas II |
| Colour | White |
| U. G. R | 19 |
| Control gear included | Yes |
| Control gear | DALI wireless Casamby |
| Flicker Free | Yes |
| Light source | LED |
| Type of LED | COB |
| Colour temperature (K) | 4000 |
| Colour consistency (SDCM) | SDCM<3 |
| CRI | 90 |