



ZENITH IP65R X2 Smart

Lavov downlight from the family ZENITH IP65R X2 Smart with a power of 2X20W and a 12 degrees beam angle. CCT 3000K. Black color. With a total lumen output of 2X1600lm and a luminous efficacy of 80lm/W. Made in Die Cast Aluminum. IP65degree of protection. Class II isolation. DALI wireless Casamby driver. UGR19. CRI90.

Dimensions

Product dimensions (mm) $\Phi 125 \times 239 \times H122 \text{mm}$

Scheme

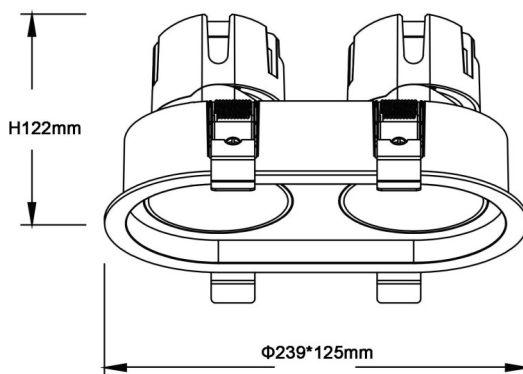

Item code	86.D284.2319.02
Product type	Indoor
Category	Downlights
Family	ZENITH
Subfamily	ZENITH IP65R X2 Smart
Pictograms	

Product	
Real power (W)	2X20
Real luminous flux (Lm)	2X1600
Luminous efficiency (Lm/W)	80
Beam angle (°)	12
Life time (h)	50000 h L80B10
IP	65
Electrical class insulation	Clas II
Colour	Black
U. G. R	19
Control gear included	Yes
Control gear	DALI wireless Casamby
Flicker Free	Yes
Light source	LED
Type of LED	COB
Colour temperature (K)	3000
Colour consistency (SDCM)	SDCM3
CRI	90