



ZENITH IP65R X2

Lavov downlight from the family ZENITH IP65R X2 with a power of 2X20W and a 36 degrees beam angle. CCT 4000K. Black color.

With a total lumen output of 2X1600lm and a luminous efficacy of 80lm/W. Made in Die Cast Aluminum. IP65degree of protection.

Class II isolation. ON/OFFdriver. UGR19. CRI90.

Item code	86.D284.2431.02
Product type	Indoor
Category	Downlights
Family	ZENITH
Subfamily	ZENITH IP65R X2
Pictograms	

Dimensions

Product dimensions (mm) **Φ125X239xH122mm**

Scheme

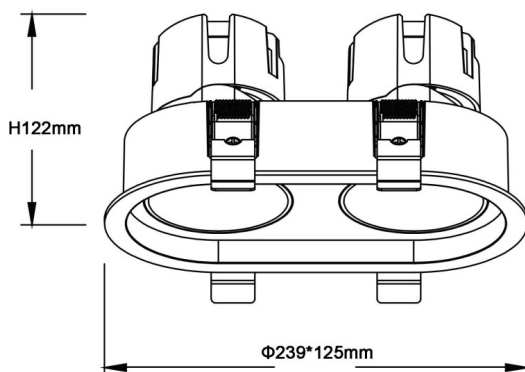

Product	
Real power (W)	2X20
Real luminous flux (Lm)	2X1600
Luminous efficiency (Lm/W)	80
Beam angle (&ordm;)	36
Life time (h)	50000 h L80B10
IP	65
Electrical class insulation	Clas II
Colour	Black
U. G. R	19
Control gear included	Yes
Control gear	ON/OFF
Flicker Free	Yes
Light source	LED
Type of LED	COB
Colour temperature (K)	4000
Colour consistency (SDCM)	SDCM<3
CRI	90