



ZENITH IP65SX2

Lavov downlight from the family ZENITH IP65SX2 with a power of 2X7W and a 24 degrees beam angle. CCT 4000K. White color. With a total lumen output of 2X560lm and a luminous efficacy of 80lm/W. Made in Die Cast Aluminum. IP65degree of protection. Class II isolation. ON/OFFdriver. UGR19. CRI90.

Dimensions

Product dimensions (mm) **130*69xH75mm**

Scheme



Item code	86.D285.0421.01
Product type	Indoor
Category	Downlights
Family	ZENITH
Subfamily	ZENITH IP65SX2

Pictograms

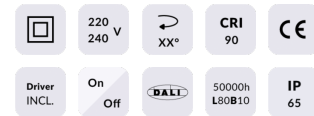

Product	
Real power (W)	2X7
Real luminous flux (Lm)	2X560
Luminous efficiency (Lm/W)	80
Beam angle (&ordm;)	24
Life time (h)	50000 h L80B10
IP	65
Electrical class insulation	Clas II
Colour	White
U. G. R	19
Control gear included	Yes
Control gear	ON/OFF
Flicker Free	Yes
Light source	LED
Type of LED	COB
Colour temperature (K)	4000
Colour consistency (SDCM)	SDCM<3
CRI	90