



### LIGHT HOLE

Lavov Downlights from the family LIGHT HOLE ,power 10 W and CRI 80 with an optic 40 degrees made in Die Cast Aluminum finished in White with a real lumen output of 900lm and an efficiency of 90lm/W. ON/OFF driver.

<b>Item code</b>	<b>86.D416.1331.01</b>
<b>Product type</b>	<b>Indoor</b>
<b>Category</b>	<b>Downlights</b>
<b>Family</b>	<b>LIGHT HOLE</b>

#### Pictograms

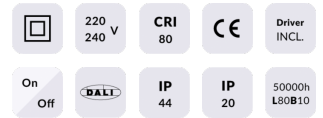

#### Scheme

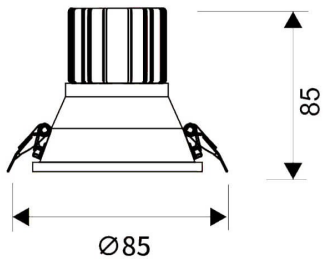

#### Product

<b>Real power (W)</b>	<b>10</b>
<b>Real luminous flux (Lm)</b>	<b>900</b>
<b>Luminous efficiency (Lm/W)</b>	<b>90</b>
<b>Beam angle (°)</b>	<b>40</b>
<b>Life time (h)</b>	<b>50000 h L80B10</b>
<b>IP</b>	<b>20</b>
<b>Electrical class insulation</b>	<b>Clas II</b>
<b>Colour</b>	<b>White</b>
<b>Control gear included</b>	<b>Yes</b>
<b>Control gear</b>	<b>ON/OFF</b>
<b>Flicker Free</b>	<b>Yes</b>
<b>Light source</b>	<b>LED</b>
<b>Type of LED</b>	<b>COB</b>
<b>Colour temperature (K)</b>	<b>3000</b>
<b>Colour consistency (SDCM)</b>	<b>SDCM&lt;3</b>
<b>CRI</b>	<b>80</b>