



LIGHT HOLE

Lavov Downlights from the family LIGHT HOLE ,power 10 W and CRI 80 with an optic 38 degrees made in Die Cast Aluminum finished in White with a real lumen output of 900lm and an efficiency of 90lm/W. ON/OFF driver.

Item code 86.D516.1321.01

Product type Indoor

Category Downlights

Family LIGHT HOLE

Pictograms



Scheme

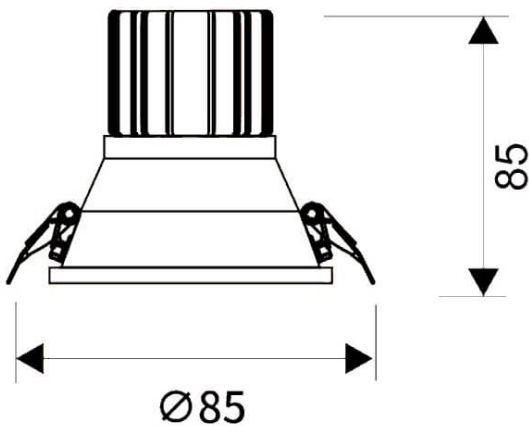

Product

Real power (W) 10

Real luminous flux (Lm) 900

Luminous efficiency (Lm/W) 90

Beam angle (°) 38

Life time (h) 50000 h L80B10

IP 20

Electrical class insulation Clas II

Colour White

Control gear included Yes

Control gear ON/OFF

Flicker Free Yes

Light source LED

Type of LED COB

Colour temperature (K) 3000

Colour consistency (SDCM) SDCM<3

CRI 80