

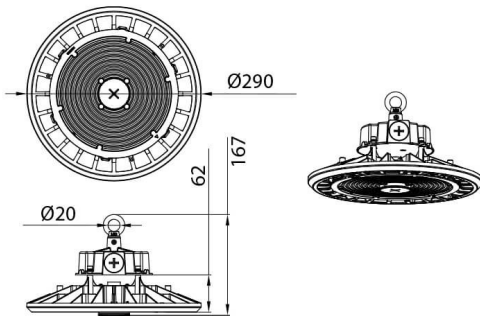

DRACO II

Lavov High bay from the family DRACO II with a power of 100W (selectable 60/80/100) and an optics 60 degrees . CCT 4000K. With a total lumen output of 14000lm and a luminous efficiency of 140lm/W.0-10V Dimmable driver. Made in die cast aluminum and finished in Black color. IP65 and IK 08 degree of protection.

Scheme



Item code	86.I016.1422.02
Product type	Indoor
Category	Industrial
Family	DRACO II
Subfamily	DRACO II
Pictograms	

Product	
Real power (W)	100
Real luminous flux (Lm)	14000
Luminous efficiency (Lm/W)	140
Beam angle (°)	60
Life time (h)	50000h L70B10
IP	65
Colour	Black
Control gear included	Yes
Control gear	0-10V Dimmable
Light source	LED
Type of LED	2835
Colour temperature (K)	4000
Colour consistency (SDCM)	SDCM5
CRI	80
IK	08