



### DRACO II

Lavov High bay from the family DRACO II with a power of 100W (selectable 60/80/100) and an optics 90 degrees . CCT 4000K. With a total lumen output of 14000lm and a luminous efficiency of 140lm/W.DALI Dimmable driver. Made in die cast aluminum and finished in Black color. IP65 and IK 08 degree of protection.

**Item code** 86.I016.1433.02

**Product type** Indoor

**Category** Industrial

**Family** DRACO II

**Subfamily** DRACO II

**Pictograms**



### Scheme

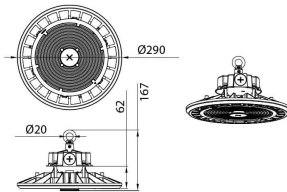

### Product

**Real power (W)** 100

**Real luminous flux (Lm)** 14000

**Luminous efficiency (Lm/W)** 140

**Beam angle (°)** 90

**Life time (h)** 50000h L70B10

**IP** 65

**Colour** Black

**Control gear included** Yes

**Control gear** DALI Dimmable

**Light source** LED

**Type of LED** 2835

**Colour temperature (K)** 4000

**Colour consistency (SDCM)** SDCM<5

**CRI** 80

**IK** 08