



DRACO II

Lavov High bay from the family DRACO II with a power of 150W (selectable 90/120/150) and an optics 60 degrees . CCT 4000K. With a total lumen output of 21000lm and a luminous efficiency of 140lm/W.DALI Dimmable driver. Made in die cast aluminum and finished in Black color. IP65 and IK 08 degree of protection.

Item code	86.I016.2423.02
------------------	------------------------

Product type	Indoor
---------------------	---------------

Category	Industrial
-----------------	-------------------

Family	DRACO II
---------------	-----------------

Subfamily	DRACO II
------------------	-----------------

Pictograms	    
-------------------	---

220
240 VCRI
80Driver
INCL.On
Off

1-10V

50000h
L70B10

Scheme

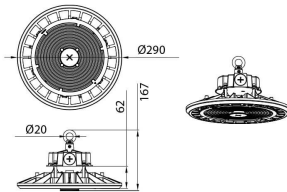

Product

Real power (W)	150
-----------------------	------------

Real luminous flux (Lm)	21000
--------------------------------	--------------

Luminous efficiency (Lm/W)	140
-----------------------------------	------------

Beam angle (°)	60
-----------------------	-----------

Life time (h)	50000h L70B10
----------------------	----------------------

IP	65
-----------	-----------

Colour	Black
---------------	--------------

Control gear included	Yes
------------------------------	------------

Control gear	DALI Dimmable
---------------------	----------------------

Light source	LED
---------------------	------------

Type of LED	2835
--------------------	-------------

Colour temperature (K)	4000
-------------------------------	-------------

Colour consistency (SDCM)	SDCM<5
----------------------------------	------------------

CRI	80
------------	-----------

IK	08
-----------	-----------