



DRACO II

Lavov High bay from the family DRACO II with a power of 200W (selectable 120/160/200) and an optics 60 degrees . CCT 4000K. With a total lumen output of 28000lm and a luminous efficiency of 140lm/W.DALI Dimmable driver. Made in die cast aluminum and finished in Black color. IP65 and IK 08 degree of protection.

| | |
|------------------|------------------------|
| Item code | 86.I016.3423.02 |
|------------------|------------------------|

| | |
|---------------------|---------------|
| Product type | Indoor |
|---------------------|---------------|

| | |
|-----------------|-------------------|
| Category | Industrial |
|-----------------|-------------------|

| | |
|---------------|-----------------|
| Family | DRACO II |
|---------------|-----------------|

| | |
|------------------|-----------------|
| Subfamily | DRACO II |
|------------------|-----------------|

| | |
|-------------------|---|
| Pictograms |      |
|-------------------|---|



Scheme

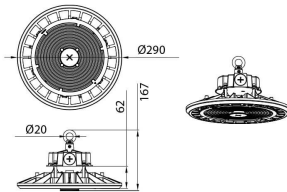

Product

| | |
|-----------------------|------------|
| Real power (W) | 200 |
|-----------------------|------------|

| | |
|--------------------------------|--------------|
| Real luminous flux (Lm) | 28000 |
|--------------------------------|--------------|

| | |
|-----------------------------------|------------|
| Luminous efficiency (Lm/W) | 140 |
|-----------------------------------|------------|

| | |
|-----------------------|-----------|
| Beam angle (°) | 60 |
|-----------------------|-----------|

| | |
|----------------------|----------------------|
| Life time (h) | 50000h L70B10 |
|----------------------|----------------------|

| | |
|-----------|-----------|
| IP | 65 |
|-----------|-----------|

| | |
|---------------|--------------|
| Colour | Black |
|---------------|--------------|

| | |
|------------------------------|------------|
| Control gear included | Yes |
|------------------------------|------------|

| | |
|---------------------|----------------------|
| Control gear | DALI Dimmable |
|---------------------|----------------------|

| | |
|---------------------|------------|
| Light source | LED |
|---------------------|------------|

| | |
|--------------------|-------------|
| Type of LED | 2835 |
|--------------------|-------------|

| | |
|-------------------------------|-------------|
| Colour temperature (K) | 4000 |
|-------------------------------|-------------|

| | |
|----------------------------------|------------------|
| Colour consistency (SDCM) | SDCM<5 |
|----------------------------------|------------------|

| | |
|------------|-----------|
| CRI | 80 |
|------------|-----------|

| | |
|-----------|-----------|
| IK | 08 |
|-----------|-----------|