



IPLINE

Lavov linear system from the family IPLINE with a power of 61W and a beam angle of 108°. Finished in White colour. Dimensions L2449mm×W50mm×H80mm. With a total lumen output of 5490lm and a luminous efficacy of 90lm/W. Made in Extruded Aluminium. Driver ON-OFF. CCT 3000K.

Dimensions	
Product dimensions (mm)	L2449mm×W50mm×H80mm

Scheme

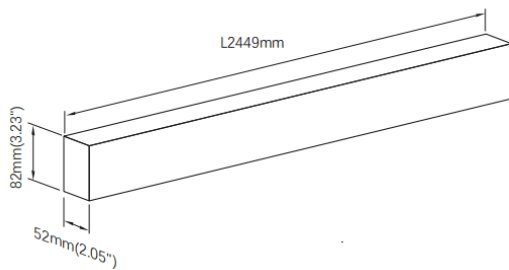

Item code	86.L004.3301.01
Product type	Indoor
Category	Linear Systems
Family	IPLINE
Pictograms	

Product	
Real power (W)	61
Real luminous flux (Lm)	5490
Luminous efficiency (Lm/W)	90
Beam angle (°)	108
Life time (h)	50000h L80B10
IP	65
Colour	White
U. G. R	22
Control gear included	Yes
Control gear	ON-OFF
Light source	LED
Type of LED	SMD
Average life time (h)	50000h L80B10
Colour temperature (K)	3000
Colour consistency (SDCM)	SDCM3
CRI	80