

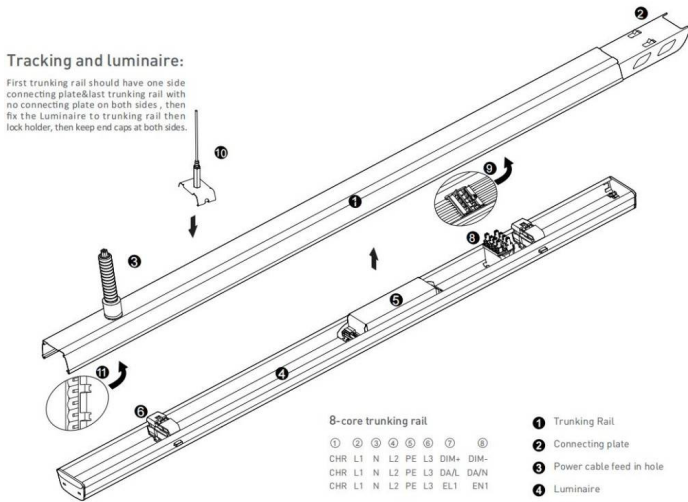

- Installation and wiring of luminaire must be in accordance with all applicable local codes.
- Installation, inspection, and maintenance of luminaires should be performed by a qualified electrician.
- DO NOT make or alter any open holes in the luminaire. Do not modify the luminaire.
- DO NOT install damaged product.
- Make sure electrical power is OFF before and during installation and maintenance.
- Make sure the equipment is properly grounded.
- Make sure the supply voltage is same as the rated fixture voltage.

Tracking and luminaire:

First trunking rail should have one side connecting plate & last trunking rail with no connecting plate on both sides, then fix the Luminaire to trunking rail then lock holder, then keep end caps at both sides.



8-core trunking rail

- ① ② ③ ④ ⑤ ⑥ ⑦ ⑧
- CHR L1 N L2 PE L3 DIM+ DIM-
- CHR L1 N L2 PE L3 DA/L DA/N
- CHR L1 N L2 PE L3 EL1 EN1

12-core trunking rail

Definition of 5-core 8-core and 12-core trunking rail

- 5-core trunking rail** ① ② ③ ④ ⑤
- L1 N L2 PE L3

- ① ② ③ ④ ⑤ ⑥ ⑦ ⑧ ⑨ ⑩ ⑪ ⑫
- CHR L1 N L2 PE L3 DIM+ DIM- EL1 EN1 EN2 EL2
- CHR L1 N L2 PE L3 DIM+ DIM- EL1 EN1 EN2 EL2
- CHR L1 N1 L2 PE L3 DA/L DA/N L4 N2 L5 L6

- ① Trunking Rail
- ② Connecting plate
- ③ Power cable feed in hole
- ④ Luminaire
- ⑤ Driver
- ⑥ Lock holder
- ⑦ Male connector
- ⑧ Female connector
- ⑨ Installation cord

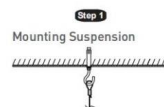

Adjust length of suspension cord:
a. press down Hexagon bolt;
b. Pull in/out cord to adjust length

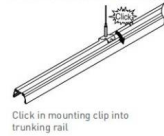

Put in conduit with cable inside and pull up conduit gland to lock



Connect wires according labeling on wires to feed in connector then connect to connector in trunking rail



Both trunking rails should keep in perfect position then push to click



Click in mounting clip into trunking rail

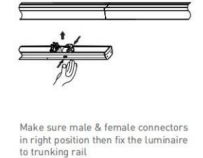

Slide knob to select phase L1/L2/L3

Make sure male & female connectors in right position then fix the luminaire to trunking rail

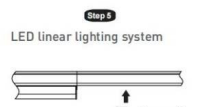

Including luminaires

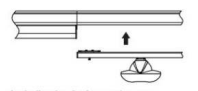

Including luminaires and sensor

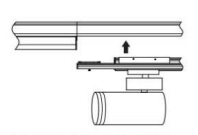

Including luminaires and spotlight

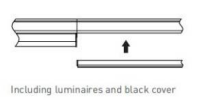

Including luminaires and black cover

Wire diagram of triple circuits function

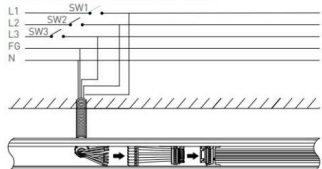

This Triple Circuits function offers to control lighting ON/OFF by three switches SW1, SW2, SW3 which are connected by live lines L1, L2, L3

Pendant and mounting installation

Starting Installation distances point should be 800 mm to 1000 mm, then in between 1st & 2nd point should be 3000 mm max

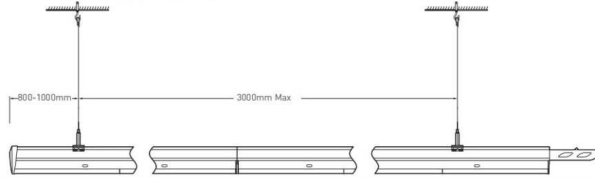

Four options for installation



Safety notes:
Installation should be performed only by qualified electrician.

- Make sure no voltage while installation.
- Connect cable wires according to wire labeling.
- Max current should not exceed 16A in one power feed in circuit.

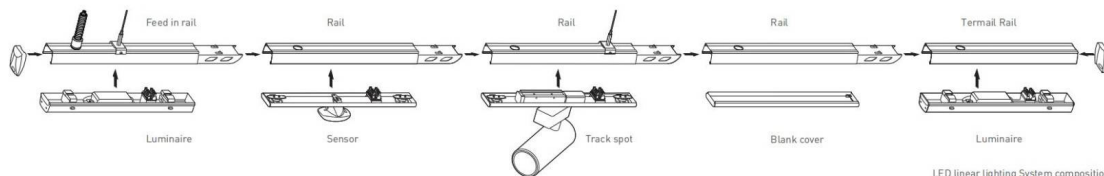

LED linear lighting System composition

Terminal module:

Terminal module can be independently installed as a single unit, it also can be connected at end of one linear light row.

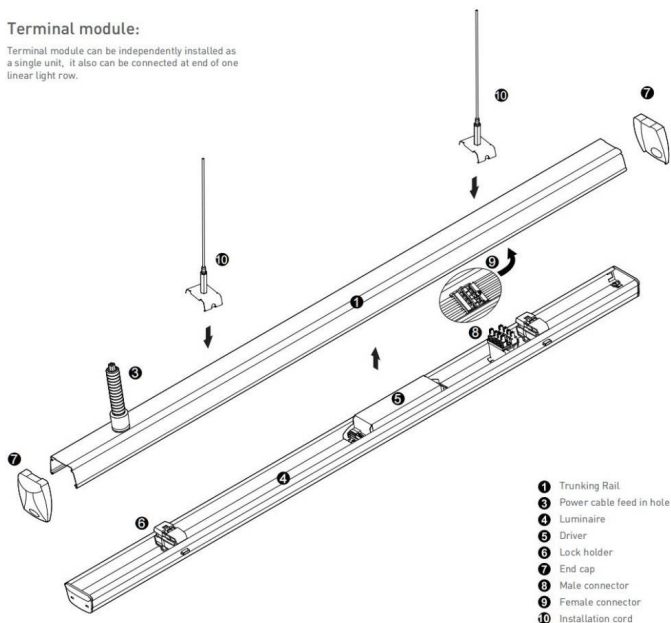

Step 1
Mounting Suspension

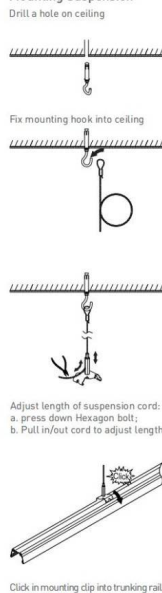

Step 2
Connecting Power Supply



Step 3
Mounting Luminaire

