











SLOT-RM

Lavov bollard from the family SLOT-RM, with a power of 12W and a 360 degrees beam angle. Finished in Black colour. Dimensions $\varnothing 118 \times H500 \text{mm}$. With a total lumen output of 1080lm and a luminous efficiency of 90lm/W. CCT 3000K. Driver ON-OFF. Made in Die Cast Aluminium Body, extruded aluminium pole, PC diffuser. .IP66. IK09

Dimensions	
Product dimensions (mm)	$\varnothing 118 \times H500 \text{mm}$

Item code	86.OB22.2301.02
Product type	Outdoor
Category	Bollards
Family	SLOT-RM
Pictograms	       

Scheme

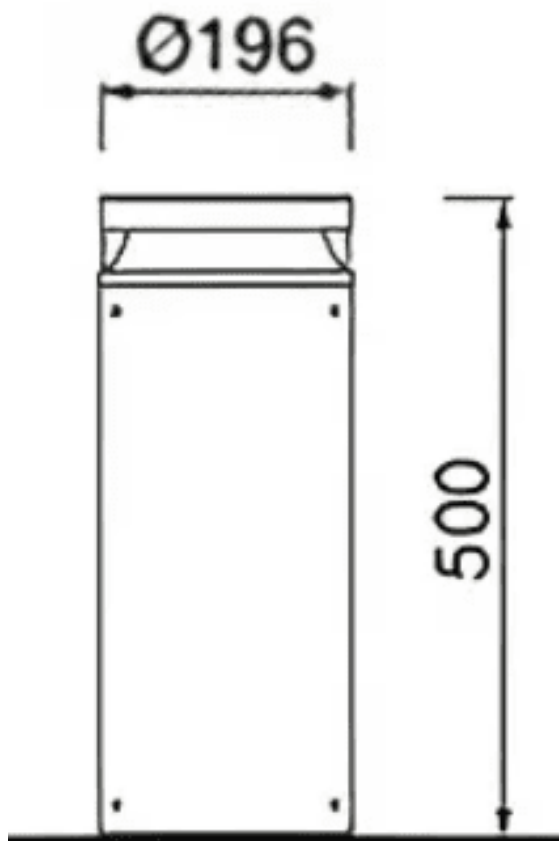

Product	
Real power (W)	12
Real luminous flux (Lm)	1080
Luminous efficiency (Lm/W)	90
Beam angle (°)	360
Life time (h)	50000h L80B10
IP	IP66
Colour	Black
Control gear included	Yes
Control gear	ON-OFF
Light source	LED
Type of LED	SMD
Colour temperature (K)	3000
Colour consistency (SDCM)	SDCM3
CRI	90
IK	IK09