



PILAR

Lavov Ceiling downlight from the family PILAR with a power of 25W and a 60 beam angle. Finished in Black colour. Dimensions 92x92x100 mm.. With a total lumen output of 2000lm and a luminous efficiency of 80lm/W. CCT 3000K. Driver DALI. Made in Die Cast Aluminium Body, Front Cover Tempered Glass. .IP65.

Dimensions

Product dimensions (mm) **92x92x100 mm**

Scheme

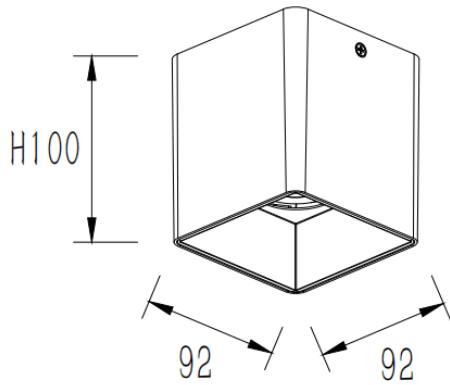

Item code	86.OC01.2333.02
Product type	Outdoor
Category	Surface Ceiling Downlight
Family	PILAR
Pictograms	

Product	
Real power (W)	25
Real luminous flux (Lm)	2000
Luminous efficiency (Lm/W)	80
Beam angle (°)	60
Life time (h)	50000h L80B10
IP	IP65
Colour	Black
Control gear included	Yes
Control gear	DALI
Light source	LED
Type of LED	COB
Average life time (h)	30
Colour temperature (K)	3000
Colour consistency (SDCM)	SDCM3
CRI	80