



DRIVE ON R

Lavov Recessed Inground from the family DRIVE ON R with a power of 4,5W and a 36 degrees beam angle. With a total lumen output of 340lm and a luminous efficiency of 75,5lm/W. Made in Die Cast Aluminium Body, Front Ring stainless Steel, Tempered Glass Cover and finished in Stainless steel colour. IP67 and IK10 degree of protection ON-OFF driver.

Dimensions

Product dimensions (mm) **Ø50mmx75mm**

Scheme

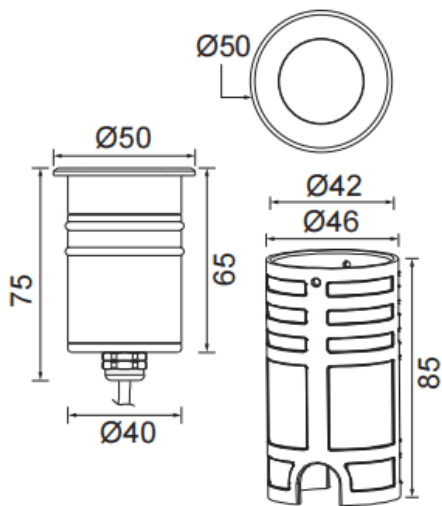

Photometry

Item code	86.OI09.0331.07
Product type	Outdoor
Category	Recessed Inground Floor
Family	DRIVE ON
Subfamily	DRIVE ON R
Pictograms	

Product	
Real power (W)	4.5
Real luminous flux (Lm)	340
Luminous efficiency (Lm/W)	75.5
Beam angle (°)	36
Life time (h)	50000h L80B10
IP	67
Electrical class insulation	Class I
Colour	Stainless steel
Control gear included	Yes
Control gear	ON-OFF
Light source	CREE 1304
Colour temperature (K)	3000
Colour consistency (SDCM)	SDCM3
CRI	80
IK	IK10

**RECESSED INGROUND FLOOR - DRIVE
ON**

Item code 86.OI09.0331.07

