



DRIVE ON R

Lavov Recessed Inground from the family DRIVE ON R with a power of 10W and a 24 degrees beam angle. With a total lumen output of 720lm and a luminous efficiency of 72lm/W. Made in Die Cast Aluminium Body, Front Ring stainless Steel, Tempered Glass Cover and finished in Stainless steel colour. IP67 and IK10 degree of protection ON-OFF driver.

Item code	86.OI09.2321.07
Product type	Outdoor
Category	Recessed Inground Floor
Family	DRIVE ON
Subfamily	DRIVE ON R

Pictograms	
-------------------	--

Dimensions

Product dimensions (mm) Ø80mmx100mm

Scheme

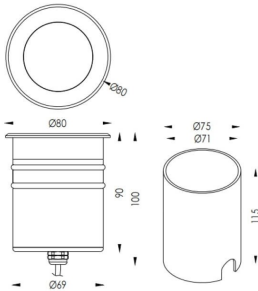

Product	
Real power (W)	10
Real luminous flux (Lm)	720
Luminous efficiency (Lm/W)	72
Beam angle (°)	24
Life time (h)	50000h L80B10
IP	67
Electrical class insulation	Class I
Colour	Stainless steel
Control gear included	Yes
Control gear	ON-OFF
Light source	CREE 1512
Colour temperature (K)	3000
Colour consistency (SDCM)	SDCM<3
CRI	80
IK	IK10