



DRIVE ON S

Lavov Recessed Inground from the family DRIVE ON S with a power of 6,5W and a 55 degrees beam angle. With a total lumen output of 720lm and a luminous efficiency of 69,85lm/W. Made in Die Cast Aluminium Body, Front Ring stainless Steel, Tempered Glass Cover and finished in Stainless steel colour. IP67 and IK10 degree of protection ON-OFF driver.

Dimensions

Product dimensions (mm) 80x80x100mm

Scheme

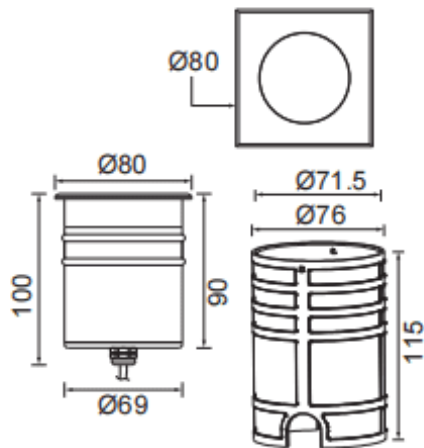

Item code	86.OI10.2341.07
Product type	Outdoor
Category	Recessed Inground Floor
Family	DRIVE ON
Subfamily	DRIVE ON S
Pictograms	

Product	
Real power (W)	10
Real luminous flux (Lm)	720
Luminous efficiency (Lm/W)	72
Beam angle (°)	55
Life time (h)	50000h L80B10
IP	67
Electrical class insulation	Class I
Colour	Stainless steel
Control gear included	Yes
Control gear	ON-OFF
Light source	LED
Type of LED	CREE 1512
Colour temperature (K)	3000
Colour consistency (SDCM)	SDCM3
CRI	80
IK	IK10