



ING-SMINI

Lavov recessed in-ground floor from the family ING-SMINI, with a power of 1.2W and a 25 degrees beam angle. Finished in Stainless steel colour. Dimensions $\varnothing 38 \times 65 \text{mm}$. With a total lumen output of 110lm and a luminous efficiency of 91.5lm/W. CCT 3000. Driver Not included. Made in Die Cast Aluminium Body, Front Ring stainless Steel, Tempered Glass Cover. IP67. IK07

Dimensions

Product dimensions (mm) $\varnothing 38 \times 65 \text{mm}$

Scheme

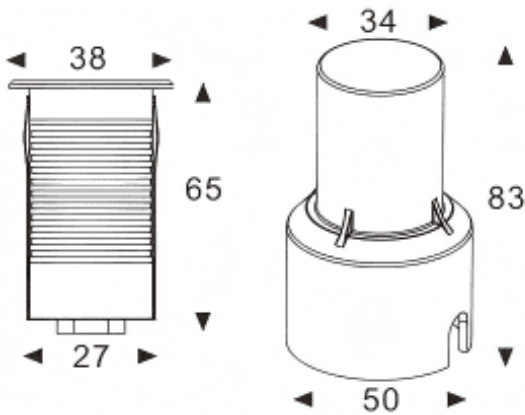

Photometry

Item code	86.OI18.1311.07
Product type	Outdoor
Category	Recessed Inground Floor
Family	ING-SMINI
Pictograms	

Product	
Real power (W)	1.2
Real luminous flux (Lm)	110
Luminous efficiency (Lm/W)	91.5
Beam angle (º)	25
Life time (h)	50000h L80B10
IP	67
Electrical class insulation	Class I
Colour	Stainless steel
Control gear included	No
Control gear	Not included
Light source	1X1,5 Osram
Colour temperature (K)	3000
Colour consistency (SDCM)	SDCM<3
CRI	80
IK	IK07

