



ING-AD

Lavov recessed in-ground floor from the family ING-AD adjustable, with a power of 12.8W and a 8 degrees beam angle. Finished in Stainless steel colour. Dimensions $\varnothing 160 \times 153 \text{mm}$. With a total lumen output of 920lm and a luminous efficiency of 71.90000000000006lm/W. CCT 3000. Driver ON-OFF. Made in Die Cast Aluminium Body, Front Ring stainless Steel, Tempered Glass Cover. IP67. IK10

Dimensions	
Product dimensions (mm)	$\varnothing 160 \times 153 \text{mm}$

Scheme	
--------	--

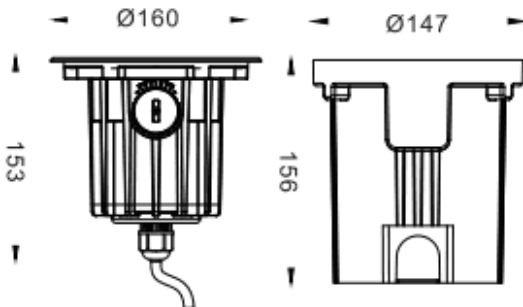

Item code	86.OI20.3321.07
Product type	Outdoor
Category	Recessed Inground Floor
Family	ING
Subfamily	ING-AD

Pictograms

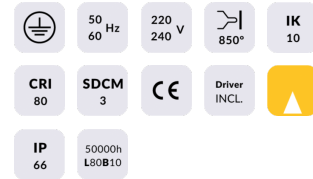

Product	
Real power (W)	12.8
Real luminous flux (Lm)	920
Luminous efficiency (Lm/W)	71.90000000000006
Beam angle (°)	8
Life time (h)	50000h L80B10
IP	67
Electrical class insulation	Class I
Colour	Stainless steel
Control gear included	Yes
Control gear	ON-OFF
Light source	LED
Type of LED	6x2W CREE
Colour temperature (K)	3000
Colour consistency (SDCM)	SDCM3
CRI	80
IK	IK10