



### ING-AD

Lavov recessed inground floor from the family ING-AD adjustable, with a power of 25,8W and a 8 degrees beam angle. Finished in Stainless steel colour. Dimensions  $\varnothing 210 \times 181 \text{mm}$ . With a total lumen output of 1850lm and a luminous efficiency of 71,7lm/W. CCT 3000. Driver ON-OFF. Made in Die Cast Aluminium Body, Front Ring stainless Steel, Tempered Glass Cover. IP67. IK10

#### Dimensions

Product dimensions (mm)  $\varnothing 210 \times 181 \text{mm}$

#### Scheme

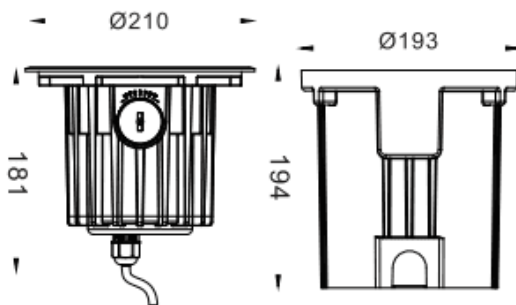

Item code	86.OI20.5321.07
Product type	Outdoor
Category	Recessed Inground Floor
Family	ING
Subfamily	ING-AD
Pictograms	

#### Product

Real power (W)	25.8
Real luminous flux (Lm)	1850
Luminous efficiency (Lm/W)	71.7
Beam angle (°)	8
Life time (h)	50000h L80B10
IP	67
Electrical class insulation	Class I
Colour	Stainless steel
Control gear included	Yes
Control gear	ON-OFF
Light source	9X3W CREE
Colour temperature (K)	3000
Colour consistency (SDCM)	SDCM3
CRI	80
IK	IK10