



### ING-XL

Lavov recessed inground floor from the family ING-XL, with a power of 20W and a 22 degrees beam angle. Finished in Stainless steel colour. Dimensions  $\varnothing 210 \times 181 \text{mm}$ . With a total lumen output of 1250lm and a luminous efficiency of 62.5lm/W. CCT 3000. Driver ON-OFF. Made in Die Cast Aluminium Body, Front Ring stainless Steel, Tempered Glass Cover. IP67. IK10

#### Dimensions

Product dimensions (mm)  $\varnothing 210 \times 181 \text{mm}$

#### Scheme

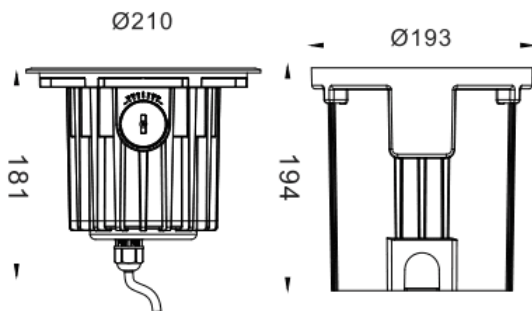

#### Photometry

Item code	86.OIN5.1321.07
Product type	Outdoor
Category	Recessed Inground Floor
Family	ING
Subfamily	ING-XL
Pictograms	

Product	
Real power (W)	20
Real luminous flux (Lm)	1250
Luminous efficiency (Lm/W)	62.5
Beam angle (°)	22
Life time (h)	50000h L80B10
IP	67
Electrical class insulation	Class I
Colour	Stainless steel
Control gear included	Yes
Control gear	ON-OFF
Light source	LED
Type of LED	1x20W CREE COB
Colour temperature (K)	3000
Colour consistency (SDCM)	SDCM3
CRI	80
IK	IK10

