



SPYKE

Lavov Spike spot light from the family Spyke with a power of 12 W and a beam angle of 25 degrees with a total lumen output of 780 lumen and an efficiency of 65lm/W. with a CCT of 3000K. Made in die cast aluminum with a front tempered glass, finished in Grey color. On-Off driver.

Item code	86.OS03.2331.03
Product type	Outdoor
Category	Spike Spot Light
Family	SPYKE
Pictograms	

Dimensions

Product dimensions (mm) 72(Dia)X128(H)M

Scheme

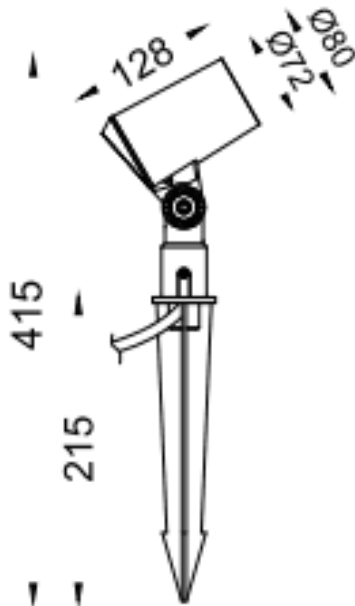

Product	
Real power (W)	12
Real luminous flux (Lm)	780
Luminous efficiency (Lm/W)	65
Beam angle (°)	25
Life time (h)	50000h L70B10
IP	66
Electrical class insulation	Class II
Colour	Grey
Chip Brand	Osram
Control gear included	Yes
Control gear	ON-OFF
Light source	LED
Type of LED	6X2W OSRAM
Average life time (h)	50000h L70B10
Colour temperature (K)	3000
Colour consistency (SDCM)	SDCM3
CRI	80
IK	IK04