



### SPYKE

Lavov Spike spot light from the family Spyke with a power of 18 W and a beam angle of 40 degrees with a total lumen output of 1200 lumen and an efficiency of 66,67lm/W. with a CCT of 3000K. Made in die cast aluminum with a front tempered glass, finished in Black color.On-Off driver.

<b>Item code</b>	<b>86.OS03.3341.02</b>
------------------	------------------------

<b>Product type</b>	<b>Outdoor</b>
---------------------	----------------

<b>Category</b>	<b>Spike Spot Light</b>
-----------------	-------------------------

<b>Family</b>	<b>SPYKE</b>
---------------	--------------

**Pictograms**



### Dimensions

**Product dimensions (mm)** 100(Dia)X160(H)M

### Scheme

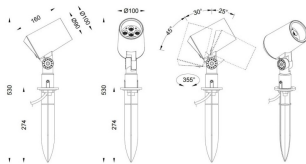

### Product

<b>Real power (W)</b>	<b>18</b>
-----------------------	-----------

<b>Real luminous flux (Lm)</b>	<b>1200</b>
--------------------------------	-------------

<b>Luminous efficiency (Lm/W)</b>	<b>66.666666666667</b>
-----------------------------------	------------------------

<b>Beam angle (°)</b>	<b>40</b>
-----------------------	-----------

<b>Life time (h)</b>	<b>50000h L70B10</b>
----------------------	----------------------

<b>IP</b>	<b>66</b>
-----------	-----------

<b>Electrical class insulation</b>	<b>Class II</b>
------------------------------------	-----------------

<b>Colour</b>	<b>Black</b>
---------------	--------------

<b>Chip Brand</b>	<b>Osram</b>
-------------------	--------------

<b>Control gear included</b>	<b>Yes</b>
------------------------------	------------

<b>Control gear</b>	<b>ON-OFF</b>
---------------------	---------------

<b>Light source</b>	<b>LED</b>
---------------------	------------

<b>Type of LED</b>	<b>6X3W OSRAM</b>
--------------------	-------------------

<b>Average life time (h)</b>	<b>50000h L70B10</b>
------------------------------	----------------------

<b>Colour temperature (K)</b>	<b>3000</b>
-------------------------------	-------------

<b>Colour consistency (SDCM)</b>	<b>SDCM&lt;3</b>
----------------------------------	------------------

<b>CRI</b>	<b>80</b>
------------	-----------

<b>IK</b>	<b>IK04</b>
-----------	-------------