

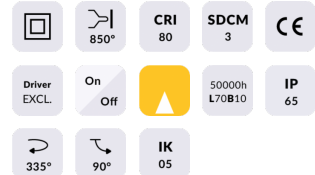

TUBEO-R

Lavov spike spot light from the family TUBEO-R with a power of 23W and a 55 degrees beam angle. With a total lumen output of 1749lm and a luminous efficiency of 76.04000000000006lm/W. Made in Die Cast Aluminum body, steel bracket and Tempered Glass cover and finished in Black colour. IP67 and IK10 degree of protection ON-OFF driver.

Item code	86.OS04.5351.02
Product type	Outdoor
Category	Spike Spot Light
Family	TUBEO-R
Subfamily	TUBEO-R
Pictograms	

Dimensions

Product dimensions (mm) 105(Dia)X120(H)mm

Scheme

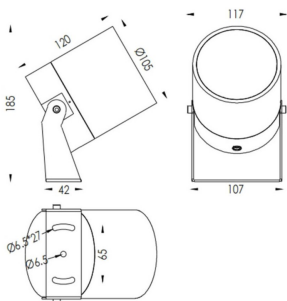

Product	
Real power (W)	23
Real luminous flux (Lm)	1749
Luminous efficiency (Lm/W)	76.04000000000006
Beam angle (°)	55
Life time (h)	50000h L70B10
IP	67
Electrical class insulation	Class II
Colour	Black
Control gear included	Yes
Control gear	ON-OFF
Light source	LED
Type of LED	1x23W CREE 1820
Average life time (h)	50000h L70B10
Colour temperature (K)	3000
Colour consistency (SDCM)	SDCM<3
CRI	80
IK	IK10