



VILA P60

Lavov Street Light from the family VILA with a power of 30W and a lighting distribution type T3A with a real lumen output of 3382,64lm, and an efficiency of 112,75 lm/W, CRI ≥ 70 with a ON-OFF driver, made in aluminium Body, Front Tempered Glass and finished in Black color. Post mounted. Post diam. 60mm.

Item code	86.OS06.1331.02
------------------	------------------------

Product type	Outdoor
---------------------	----------------

Category	Street lights
-----------------	----------------------

Family	VILA
---------------	-------------

Subfamily	VILA P60
------------------	-----------------

Pictograms	    
-------------------	---



Product

Real power (W)	30
-----------------------	-----------

Real luminous flux (Lm)	3382.64
--------------------------------	----------------

Luminous efficiency (Lm/W)	112.754666666667
-----------------------------------	-------------------------

Colour	black
---------------	--------------

Control gear included	yes
------------------------------	------------

Control gear	ON-OFF
---------------------	---------------

Light source	LED
---------------------	------------

Type of LED	PHILIPS 5050
--------------------	---------------------

Average life time (h)	50000h L70B12
------------------------------	----------------------

Colour temperature (K)	3000K
-------------------------------	--------------

Colour consistency (SDCM)	<5
----------------------------------	--------------

CRI	>80
------------	---------------

IK	IK08
-----------	-------------

Scheme

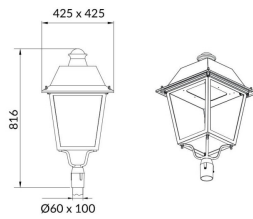

Photometry

