



VILA P60

Lavov Street Light from the family VILA with a power of 40W and a lighting distribution type T3A with a real lumen output of 3941,46lm, and an efficiency of 98,53 lm/W, CRI ≥ 70 with a ON-OFF driver, made in aluminium Body, Front Tempered Glass and finished in Black color. Post mounted. Post diam. 60mm.

Item code	86.OS06.2331.02
Product type	Outdoor
Category	Street lights
Family	VILA
Subfamily	VILA P60

Pictograms



Product	
Real power (W)	40
Real luminous flux (Lm)	3941.46
Luminous efficiency (Lm/W)	98.5365
Colour	black
Chip Brand	SUNPU
Control gear included	yes
Control gear	ON-OFF
Light source	LED
Type of LED	PHILIPS 5050
Average life time (h)	50000h L70B16
Colour temperature (K)	3000K
Colour consistency (SDCM)	<5
CRI	>80
IK	IK08

Scheme

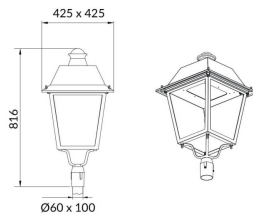

Photometry

