



Voyager II

Lavov Street light from the family Voyager II with a power of 30W and an optics type T2 . CCT 4000K. With a total lumen output of 4500lm and a luminous efficiency of 150lm/W.ON-OFF driver. Made in die cast aluminum and finished in grey color. IP66 and IK08 degree of protection.

Item code	86.OS15.1421.03
------------------	------------------------

Product type	Outdoor
---------------------	----------------

Category	Street lights
-----------------	----------------------

Family	Voyager II
---------------	-------------------

Pictograms



Dimensions

Product dimensions (mm) 419*182*100MM

Scheme

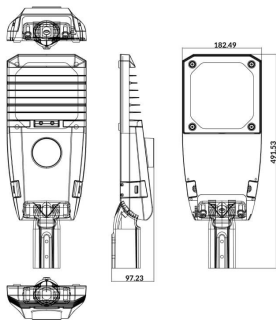

Product

Real power (W)	30
-----------------------	-----------

Real luminous flux (Lm)	4500
--------------------------------	-------------

Luminous efficiency (Lm/W)	150
-----------------------------------	------------

Beam angle (°)	T2
-----------------------	-----------

Life time (h)	70000h L70B10
----------------------	----------------------

IP	66
-----------	-----------

Electrical class insulation	Class I
------------------------------------	----------------

Colour	grey
---------------	-------------

Control gear included	yes
------------------------------	------------

Control gear	ON-OFF
---------------------	---------------

Light source	LED
---------------------	------------

Type of LED	LUMILEDS 3030
--------------------	----------------------

Average life time (h)	Up to 100,000hrs LM70,Ta 25°C
------------------------------	--------------------------------------

Colour temperature (K)	4000
-------------------------------	-------------

Colour consistency (SDCM)	SDCM<6
----------------------------------	------------------

CRI	>80
------------	---------------

IK	IK08
-----------	-------------