



Voyager II

Lavov Street light from the family Voyager II with a power of 50W and an optics type T3 . CCT 4000K. With a total lumen output of 7500lm and a luminous efficiency of 150lm/W.ON-OFF driver. Made in die cast aluminum and finished in grey color. IP66 and IK08 degree of protection.

Item code	86.OS15.3431.03
Product type	Outdoor
Category	Street lights
Family	Voyager II
Pictograms	

Dimensions

Product dimensions (mm) **419*182*100MM**

Scheme

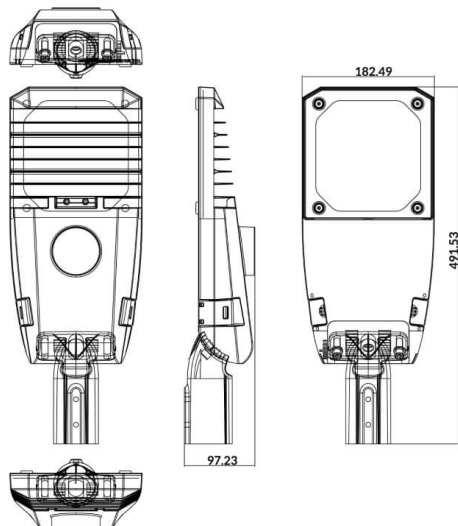

Product	
Real power (W)	50
Real luminous flux (Lm)	7500
Luminous efficiency (Lm/W)	150
Beam angle (°)	T3
Life time (h)	70000h L70B10
IP	66
Electrical class insulation	Class I
Colour	grey
Control gear included	yes
Control gear	ON-OFF
Light source	LED
Type of LED	LUMILEDS 3030
Average life time (h)	Up to 100,000hrs LM70,Ta 25°C
Colour temperature (K)	4000
Colour consistency (SDCM)	SDCM6
CRI	>80
IK	IK08