



Voyager II

Lavov Street light from the family Voyager II with a power of 240W and an optics type T2 . CCT 4000K. With a total lumen output of 36000lm and a luminous efficiency of 150lm/W.ON-OFF driver. Made in die cast aluminum and finished in grey color. IP66 and IK08 degree of protection.

Item code	86.OS15.C421.03
Product type	Outdoor
Category	Street lights
Family	Voyager II
Pictograms	

Dimensions

Product dimensions (mm) **721*313*120MM**

Scheme

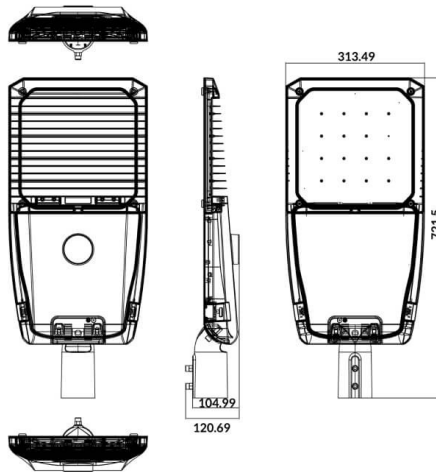

Product	
Real power (W)	240
Real luminous flux (Lm)	36000
Luminous efficiency (Lm/W)	150
Beam angle (&ordm;)	T2
Life time (h)	70000h L70B10
IP	66
Electrical class insulation	Class I
Colour	grey
Control gear included	yes
Control gear	ON-OFF
Light source	LED
Type of LED	LUMILEDS 3030
Average life time (h)	Up to 100,000hrs LM70,Ta 25°C
Colour temperature (K)	4000
Colour consistency (SDCM)	SDCM<6
CRI	>80
IK	IK08