



BELL

Lavov suspended luminaire from the family with a power of 30W and an optics of 50 degrees, made in Die Cast Aluminum with a real lumen output of 2700lm and an efficiency of 90lm/W.ON-OFF driver.

Item code	86.S002.3431.02
Product type	Indoor
Category	Pendants
Family	BELL

Pictograms



Scheme

Product	
Real power (W)	30
Real luminous flux (Lm)	2700
Luminous efficiency (Lm/W)	90
Beam angle (°)	50
Life time (h)	50000h L80B10
IP	20
Colour	Black
Chip Brand	Philip
Control gear included	Yes
Control gear	ON-OFF
Light source	LED
Type of LED	COB
Colour temperature (K)	4000
Colour consistency (SDCM)	SDCM3
CRI	80

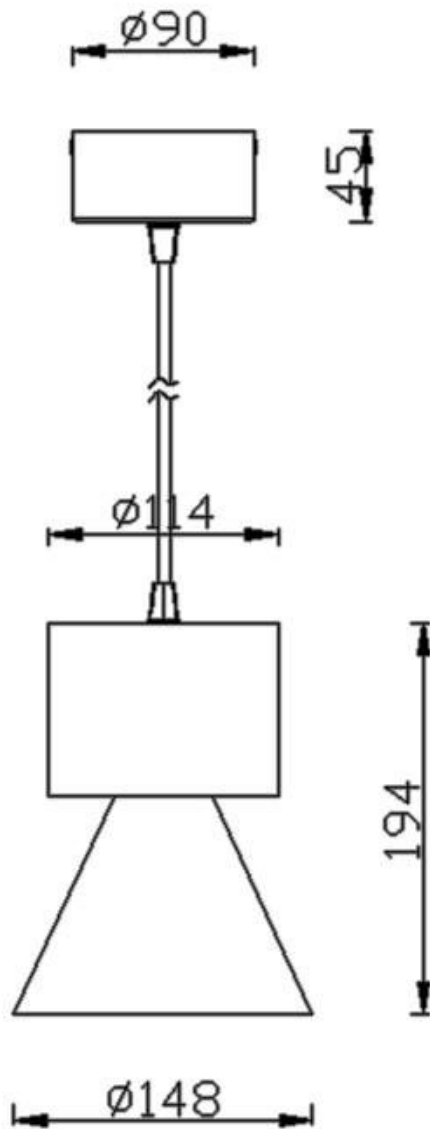

Photometry

