



### TUBULAR-S

Lavov surface mounted downlight from the family TUBULAR-S with a power of 25W and an optics 24 degrees beam angle. CCT 4000K. With a total lumen output of 2050lm and an efficacy of 82lm/W . Made in Die Cast Aluminum and finished in White color. DALI driver.

<b>Item code</b>	<b>86.SD01.2423.01</b>
<b>Product type</b>	<b>Indoor</b>
<b>Category</b>	<b>Surface Downlights</b>
<b>Family</b>	<b>TUBULAR-S</b>
<b>Pictograms</b>	

### Dimensions

**Product dimensions (mm)**      **Ø169X139 mm**

### Scheme

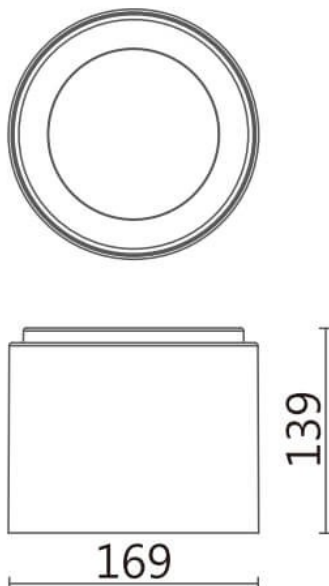

### Product

<b>Real power (W)</b>	<b>25</b>
<b>Real luminous flux (Lm)</b>	<b>2050</b>
<b>Luminous efficiency (Lm/W)</b>	<b>82</b>
<b>Beam angle (°)</b>	<b>24</b>
<b>Life time (h)</b>	<b>50000h L80B10</b>
<b>IP</b>	<b>IP20</b>
<b>Colour</b>	<b>White</b>
<b>Chip Brand</b>	<b>Philip</b>
<b>Control gear included</b>	<b>Yes</b>
<b>Control gear</b>	<b>DALI</b>
<b>Average life time (h)</b>	<b>40</b>
<b>Colour temperature (K)</b>	<b>4000</b>
<b>Colour consistency (SDCM)</b>	<b>SDCM&lt;3</b>
<b>CRI</b>	<b>80</b>