



### TUBULAR-S

Lavov surface downlight from the family with a power of 40W and a beam angle of 20°. Finished in White colour. Dimensions Ø140X162 mm. With a total lumen output of 3200lm and a luminous efficacy of 80lm/W. Made in Die Cast Aluminum. Driver ON-OFF. CCT 3000K.

Dimensions	
Product dimensions (mm)	Ø140X162 mm

### Scheme

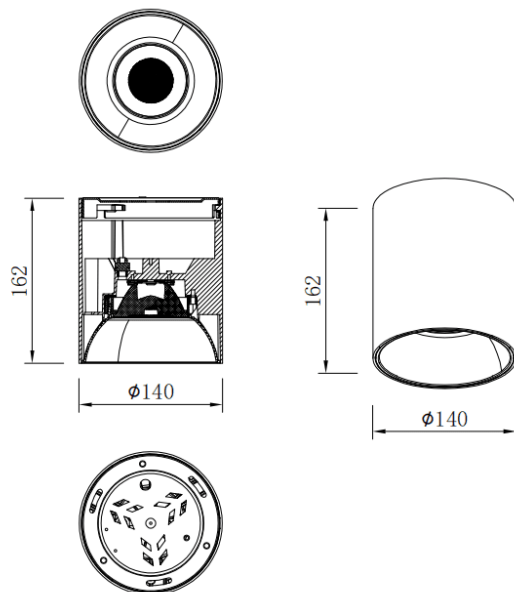

Item code	86.SD01.4321.01
Product type	Indoor
Category	Surface Downlights
Family	TUBULAR-S
Pictograms	

Product	
Real power (W)	40
Real luminous flux (Lm)	3200
Luminous efficiency (Lm/W)	80
Beam angle (°)	20
Life time (h)	50000h L80B10
IP	IP65
Colour	White
Control gear included	Yes
Control gear	ON-OFF
Light source	LED
Type of LED	COB
Colour temperature (K)	3000
Colour consistency (SDCM)	SDCM3
CRI	80