



TUBULAR-S

Lavov surface downlight from the family with a power of 50W and a beam angle of 60°. Finished in Black colour. Dimensions Ø170X182 mm .With a total lumen output of 4000lm and a luminous efficacy of 80lm/W. Made in Die Cast Aluminum. Driver DALI. CCT 3000K.

Dimensions	
Product dimensions (mm)	Ø170X182 mm

Scheme

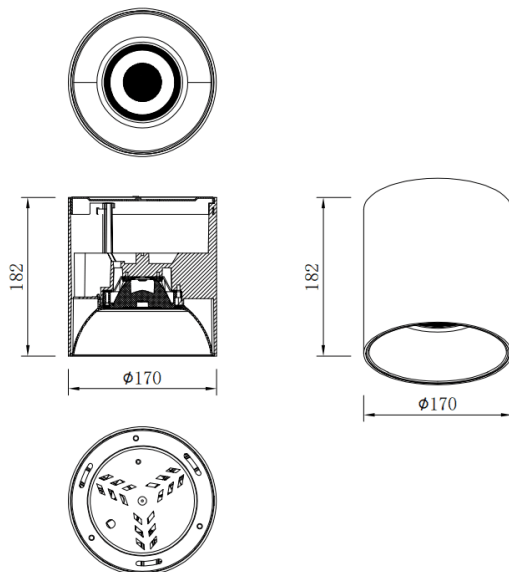

Item code	86.SD01.5343.02
Product type	Indoor
Category	Surface Downlights
Family	TUBULAR-S
Pictograms	

Product	
Real power (W)	50
Real luminous flux (Lm)	4000
Luminous efficiency (Lm/W)	80
Beam angle (º)	60
Life time (h)	50000h L80B10
IP	IP65
Colour	Black
Control gear included	Yes
Control gear	DALI
Colour temperature (K)	3000
Colour consistency (SDCM)	SDCM<3
CRI	80