



TUBULAR-S

Lavov surface downlight from the family with a power of 50W and a beam angle of 60°. Finished in Black colour. Dimensions Ø170X182 mm .With a total lumen output of 4000lm and a luminous efficacy of 80lm/W. Made in Die Cast Aluminum. Driver DALI. CCT 4000K.

Dimensions

Product dimensions (mm) **Ø170X182 mm**

Scheme

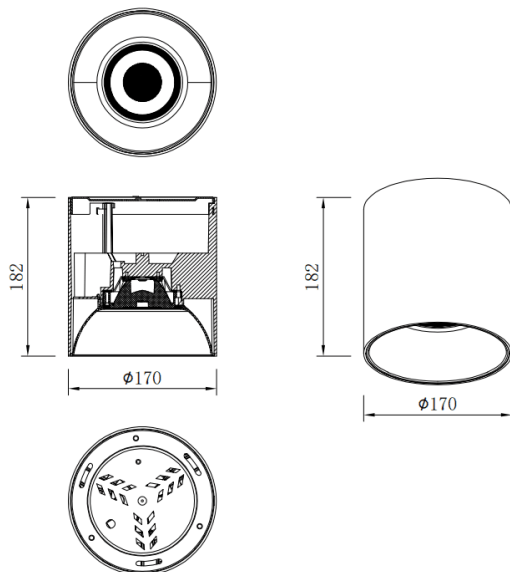

Item code	86.SD01.5443.02
Product type	Indoor
Category	Surface Downlights
Family	TUBULAR-S
Pictograms	

Product	
Real power (W)	50
Real luminous flux (Lm)	4000
Luminous efficiency (Lm/W)	80
Beam angle (°)	60
Life time (h)	50000h L80B10
IP	IP65
Colour	Black
Control gear included	Yes
Control gear	DALI
Light source	LED
Type of LED	COB
Colour temperature (K)	4000
Colour consistency (SDCM)	SDCM3
CRI	80