



TUBULAR-S

Lavov surface downlight from the family with a power of 60W and a beam angle of 40°. Finished in Silver colour. Dimensions Ø205X212 mm. With a total lumen output of 4800lm and a luminous efficacy of 80lm/W. Made in Die Cast Aluminum. Driver DALI. CCT 4000K.

Dimensions	
Product dimensions (mm)	Ø205X212 mm

Scheme

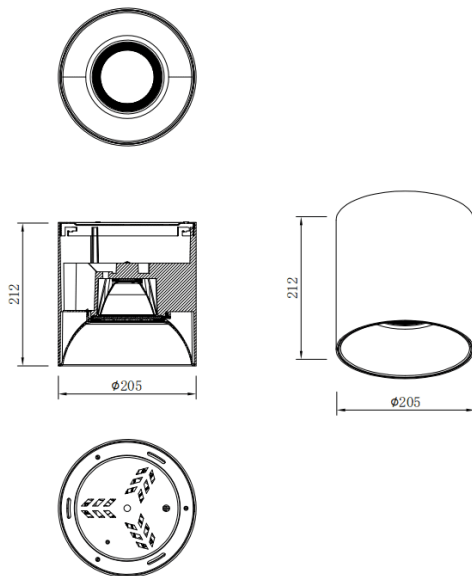

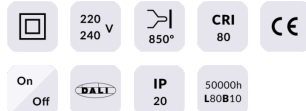
Item code	86.SD01.6433.03
Product type	Indoor
Category	Surface Downlights
Family	TUBULAR-S
Pictograms	

Product	
Real power (W)	60
Real luminous flux (Lm)	4800
Luminous efficiency (Lm/W)	80
Beam angle (°)	40
Life time (h)	50000h L80B10
IP	IP65
Colour	Silver
Control gear included	Yes
Control gear	DALI
Light source	LED
Type of LED	COB
Colour temperature (K)	4000
Colour consistency (SDCM)	SDCM3
CRI	80