



### SQUARE-S

Lavov surface downlight from the family SQUARE-S B with a power of 15W and a beam angle of 60°. Finished in White colour. Dimensions 74x74x90 mm. With a total lumen output of 1200lm and a luminous efficacy of 80lm/W. Made in Die cast aluminium. Driver DALI. CCT 4000K. IP65.

Dimensions	
Product dimensions (mm)	74x74x90 mm

### Scheme

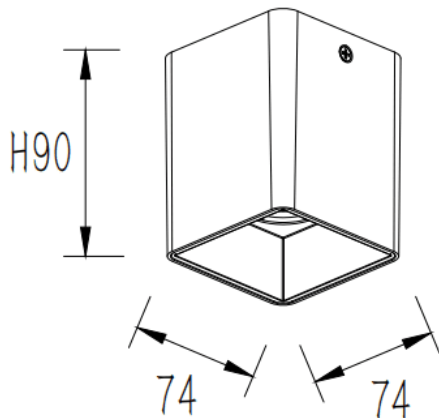

Item code	86.SD03.1433.01
Product type	Indoor
Category	Surface Downlights
Family	SQUARE-S
Pictograms	

Product	
Real power (W)	15
Real luminous flux (Lm)	1200
Luminous efficiency (Lm/W)	80
Beam angle (°)	60
Life time (h)	50000h L80B10
IP	IP65
Colour	White
Control gear included	Yes
Control gear	DALI
Light source	LED
Type of LED	COB
Colour temperature (K)	4000
Colour consistency (SDCM)	SDCM3
CRI	80