



SQUARE-S

Lavov surface downlight from the family SQUARE-S B with a power of 25W and a beam angle of 40°. Finished in Black colour. Dimensions 92x92x100mm. With a total lumen output of 2000lm and a luminous efficacy of 80lm/W. Made in Die cast aluminium. Driver ON-OFF. CCT 3000K. IP65.

Dimensions	
Product dimensions (mm)	92x92x100mm

Scheme

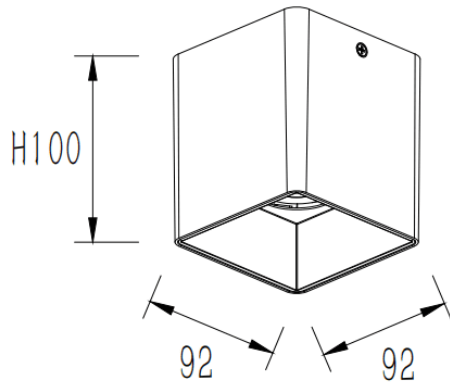

Item code	86.SD03.2321.02
Product type	Indoor
Category	Surface Downlights
Family	SQUARE-S
Pictograms	

Product	
Real power (W)	25
Real luminous flux (Lm)	2000
Luminous efficiency (Lm/W)	80
Beam angle (º)	40
Life time (h)	50000h L80B10
IP	IP65
Colour	Black
Control gear included	Yes
Control gear	ON-OFF
Colour temperature (K)	3000
Colour consistency (SDCM)	SDCM<3
CRI	80