



SQUARE-S

Lavov surface downlight from the family SQUARE-S B with a power of 35W and a beam angle of 20°. Finished in Grey colour. Dimensions 113x113x120mm. With a total lumen output of 2800lm and a luminous efficacy of 80lm/W. Made in Die cast aluminium. Driver DALI. CCT 3000K. IP65.

Dimensions

Product dimensions (mm) **113x113x120mm**

Scheme

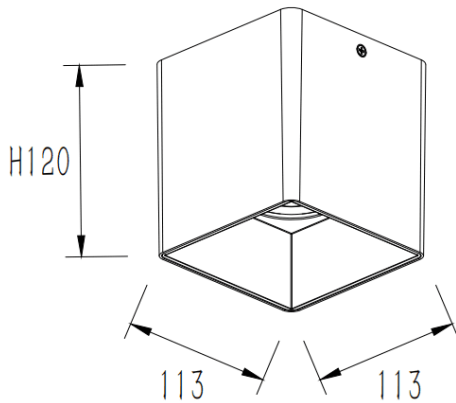

Item code	86.SD03.3313.03
Product type	Indoor
Category	Surface Downlights
Family	SQUARE-S
Pictograms	

Product	
Real power (W)	35
Real luminous flux (Lm)	2800
Luminous efficiency (Lm/W)	80
Beam angle (°)	20
Life time (h)	50000h L80B10
IP	IP65
Colour	Grey
Control gear included	Yes
Control gear	DALI
Light source	LED
Type of LED	COB
Colour temperature (K)	3000
Colour consistency (SDCM)	SDCM3
CRI	80